

NEW

OMRON

# LED Lighting System 3Z4S-LT/LE Series Datasheet



## LED NEXT GENERATION



This document provides information mainly for selecting suitable models. Please read the Instruction Sheet carefully for information that the user must understand and accept before purchase, including information on warranty, limitations of liability, and precautions.

**OMRON Corporation**  
Industrial Automation Company  
Sensing Devices Division H.Q.  
Application Sensors Division  
Shiokoji Horikawa, Shimogyo-ku,  
Kyoto, 600-8530 Japan  
Tel: (81) 75-344-7068/Fax: (81) 75-344-7107

**Regional Headquarters**  
**OMRON EUROPE B.V.**  
Sensor Business Unit  
Carl-Benz-Str. 4, D-71154 Nufringen,  
Germany  
Tel: (49) 7032-811-0/Fax: (49) 7032-811-199

**OMRON ELECTRONICS LLC**  
One Commerce Drive Schaumburg,  
IL 60173-5302 U.S.A.  
Tel: (1) 847-843-7900/Fax: (1) 847-843-7787

**OMRON ASIA PACIFIC PTE. LTD.**  
No. 438A Alexandra Road # 05-05/08 (Lobby 2),  
Alexandra Technopark, Singapore 119967  
Tel: (65) 6835-3011/Fax: (65) 6835-2711

**OMRON (CHINA) CO., LTD.**  
Room 2211, Bank of China Tower,  
200 Yin Cheng Zhong Road,  
PuDong New Area, Shanghai, 200120, China  
Tel: (86) 21-5037-2222/Fax: (86) 21-5037-2200

Authorized Distributor:

© OMRON Corporation 2008 All Rights Reserved.  
In the interest of product improvement,  
specifications are subject to change without notice.

OMRON Industrial Automation Global: [www.ia.omron.com](http://www.ia.omron.com)

Cat. No. Q164-E1-01

Printed in Japan  
0708

realizing



**LED**  
Next Generation

# Next-generation MG-Wave<sup>®</sup> LED Illumination Combines with the Vision Sensor to Provide New Solutions

Illumination Devices are essential for finding solutions to many of the image-processing tasks of Vision Sensors. With this in mind, we have now combined advanced MG-Wave<sup>®</sup> LED Illumination from the broad Moritex range of original and innovative products based on superior illumination technologies with Vision Sensor image-processing technologies and know-how accumulated over the years by OMRON.

This powerful collaboration has yielded a variety of optimal solutions to inspection and measurement needs in automated production applications.

**A wide range of products allows you to select the optimal Illumination Device for each application.**

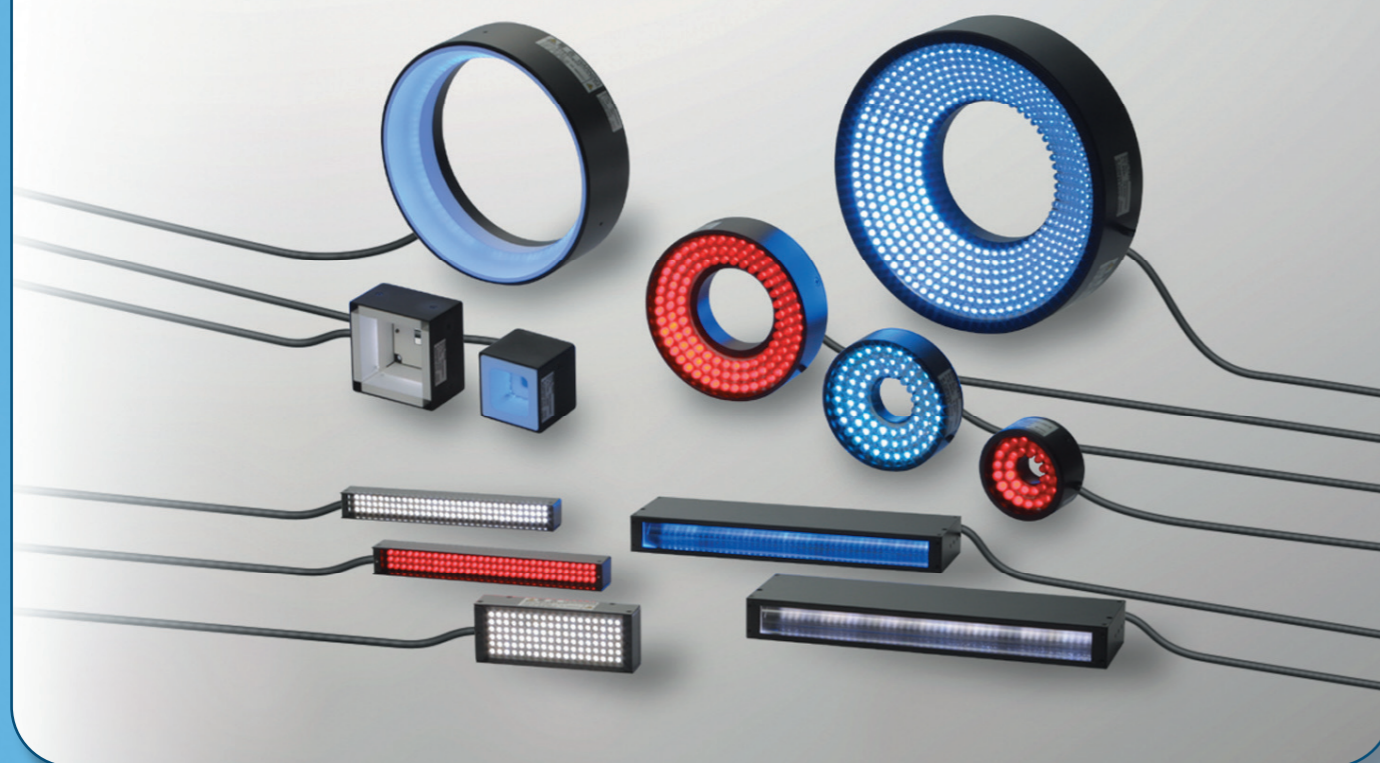

## Index

Strobe Controller	P4
Direct Ring Light	P6
Low Angle Ring Light	P7
Coaxial Light/Simulated Coaxial Episcopic Light	P8
Shadowless Light	P9
Bar Light/Line Light	P10
Dome Light	P11
High-powered Spot LED Light	P12
IR Light	P12
Direct Backlight	P13
Edge-type Backlight	P14
Square Oblique Light	P15
UV Light	P16
Spot LED Light	P17
Parallel Light	P17
CCTV Lens	P18
CCTV Lens Option	P19
Non-telecentric Macro Lens	P19
New Power Supplies for MCEP/MSPP Series	P20
New Power Supplies for MG-Wave Series	P22
Optional Accessories	P25



# Strobe Controller

3Z4S-LT MLEK-C080E1LS (for F150-S1A, F160-S2 Camera)  
 3Z4S-LT MLEK-C100E1TS2 (for FZ□ Camera)  
 3Z4S-LT MLEK-C100E1TSX (for ZFX-S/SC Camera)

Combining good Vision Sensor compatibility and excellent cost-performance.

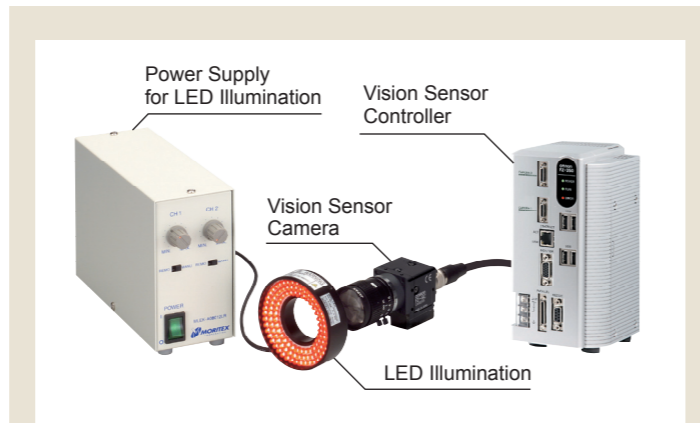
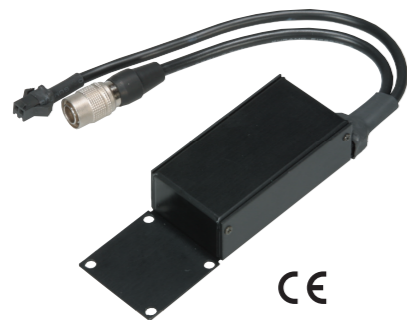

## Adding the Strobe Controller

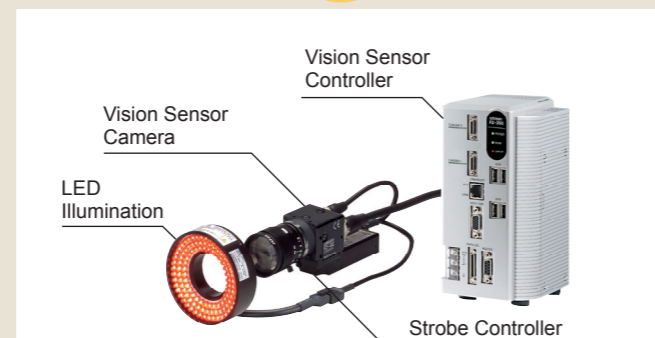

Note: This configuration can also be used with the F150-S1A, F160-S2 or ZFX-S/SC Camera.

### Three Main Features

#### No need of power supply.

The Strobe Controller operates with power supplied from the Camera Head.

#### No need of light-emission control.

The illumination is turned ON when the Strobe Controller receives a trigger signal from the Camera Head.

#### Minimal wiring.

Simply connect the Camera and Illumination Device with a single cable.

Illumination Devices up to 1 A (Output current: See note) can be connected.



No Power Supply Required  
= Large Cost Reduction

Note: When using the MLEK-C100E1TS2 and MLEK-C100E1TSX

## Ratings and Specifications

•The strobe intensity can be manually adjusted.

Model	3Z4S-LT MLEK-C080E1LS (See note 1.)	3Z4S-LT MLEK-C100E1TS2	3Z4S-LT MLEK-C100E1TSX
No. of outputs	1-channel output		
Output current	0.83 A max. (when using 0.8-A illumination) (See note 2.)	1.0 A max. (when using 1.0-A illumination) (See note 2.)	
Output control method	Constant current control		
Output form	Strobe output (synchronized with rising edge trigger)		
Output adjustment function	Manual dial only	External communications setting only (See note 3.)	
Variable output range	0 to 100%		
Strobe emission time	8.3 ms (standard)	Automatically set by FZ□ Controller	Automatically set by ZFX Controller
Strobe emission delay time	Ton: 30 μs max. (at max. setting) Toff: 10 μs max. (at max. setting)		
Allowable ON duty	100%		
Usage environment	Indoor use at a max. altitude of 2,000 m, with no inflammable or corrosive gases present, and no adhesion of foreign matter		
Ambient temperature and humidity	0 to 45°C, 80% up to 31°C and then dropping linearly to 50% at 40°C		
Storage temperature and humidity	-20 to 85°C, 20 to 80% humidity (with no condensation)		
Mounting method	Connected and mounted to F160-S2 or F150-S1A Camera	Connected and mounted to FZ-S□/FZ-S□2M Camera	Connected and mounted to ZFX-S/SC Camera
Cooling method	Natural air cooling		
Degree of protection	IP30 (IEC 60529)		
Weight	Approx. 80 g		
Extension Cable (purchased separately)	M-RCB4□□L (4-pin Extension Cable) (indicate length in the 2 square boxes (□□): 01=1m, 02 = 2 m, 03 = 3 m)		

Note 1: Illumination marked "•" in the Connection to Strobe Controller column of the Model Number Legend table can be used.

Note 2: Depends on the illumination used.

Note 3: Strobe intensity adjustment and variable range.

## Dimensions

(Unit: mm)

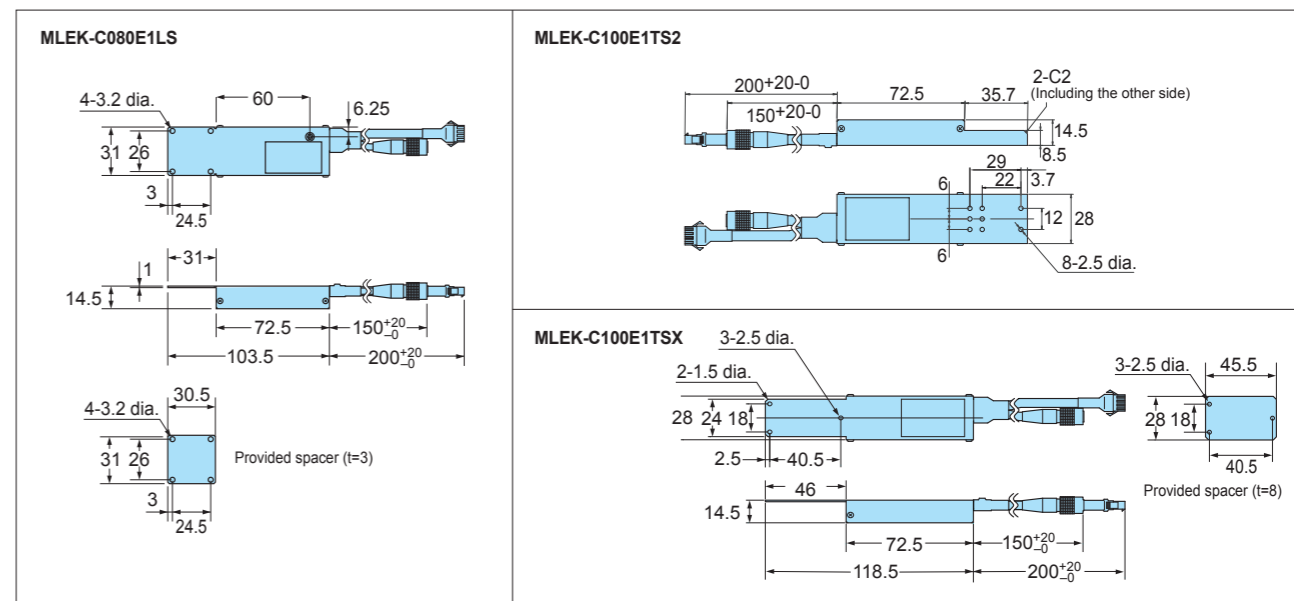

# Direct Ring Light

## Model Number Legend

3Z4S-LT MDRL-C \*  Internal diameter of the ring (mm)  
Luminescent color (Red=R, Green=G, Blue=B, White=W)

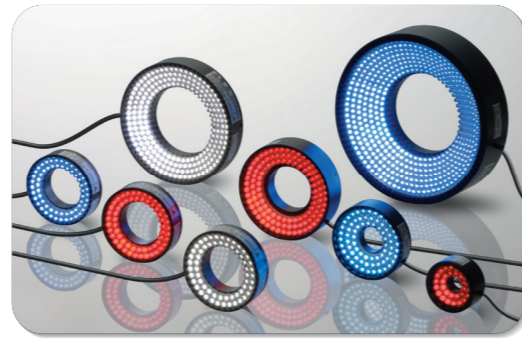

## List of Models

Model	Dimension	Luminescent Color	Max. rated current IFM (A)	Weight (g)	Power supply	Connection to strobe controller
MDRL-CR10	A	Red	0.11	50	080	○
*MDRL-CG10	A	Green	0.17		080	○
MDRL-CB10	A	Blue	0.17		080	○
MDRL-CW10	A	White	0.17		080	○
MDRL-CR16	B	Red	0.24	65	080	○
*MDRL-CG16	B	Green	0.37		080	○
MDRL-CB16	B	Blue	0.37		080	○
MDRL-CW16	B	White	0.37		080	○
MDRL-CR28	C	Red	0.20	65	080	○
*MDRL-CG28	C	Green	0.31		080	○
MDRL-CB28	C	Blue	0.31		080	○
MDRL-CW28	C	White	0.31		080	○
MDRL-CR31	D	Red	0.36	130	080	○
*MDRL-CG31	D	Green	0.55		080	○
MDRL-CB31	D	Blue	0.55		080	○
MDRL-CW31	D	White	0.55		080	○
MDRL-CR35	E	Red	0.34	150	080	○
*MDRL-CG35	E	Green	0.52		080	○
MDRL-CB35	E	Blue	0.52		080	○
MDRL-CW35	E	White	0.52		080	○
MDRL-CR36	F	Red	0.36	120	080	○
*MDRL-CG36	F	Green	0.55		080	○
MDRL-CB36	F	Blue	0.55		080	○
MDRL-CW36	F	White	0.55		080	○
MDRL-CR50	G	Red	0.64	180	080	○
*MDRL-CG50	G	Green	0.96		230	×
MDRL-CB50	G	Blue	0.96		230	×
MDRL-CW50	G	White	0.96		230	×
MDRL-CR56	H	Red	1.12	520	230	×
*MDRL-CG56	H	Green	1.55		230	×
MDRL-CB56	H	Blue	1.55		230	×
MDRL-CW56	H	White	1.55		230	×

The MDRL-C\*35 provides perpendicular illumination to enable a long working distance.  
The recommended working distance is 65 mm or longer, but if a reflective surface is being illuminated, the working distance can be as long as 200 mm. \* Production by order

## Options

Diffusion and Polarizing plates are available to prevent the vignetting of image.

For detail, [See "Adapter: MAD Series" on page 25.](#)

## Dimensions

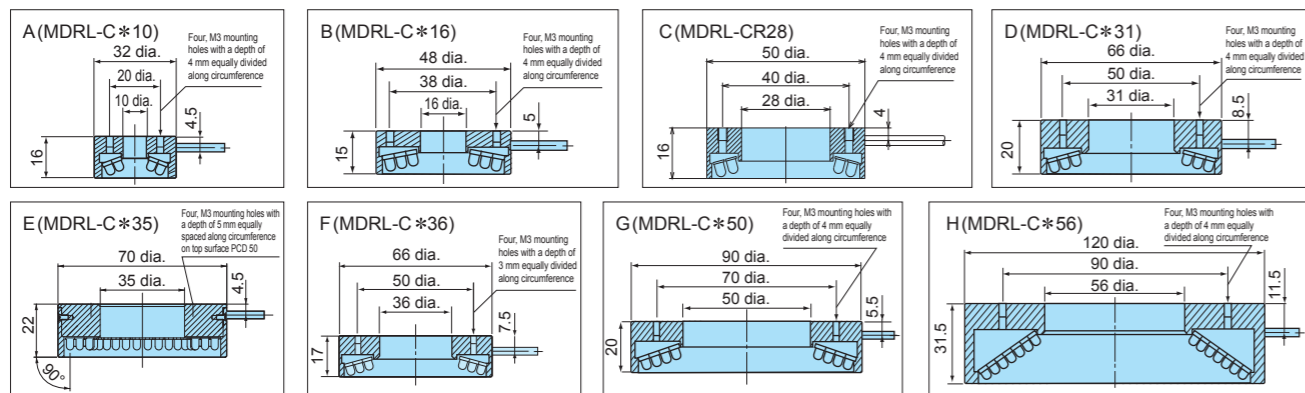

# Low Angle Ring Light

## Model Number Legend

3Z4S-LT MLRL-C \*  Internal diameter of the ring (mm)  
Luminescent color (Red=R, Green=G, Blue=B, White=W)

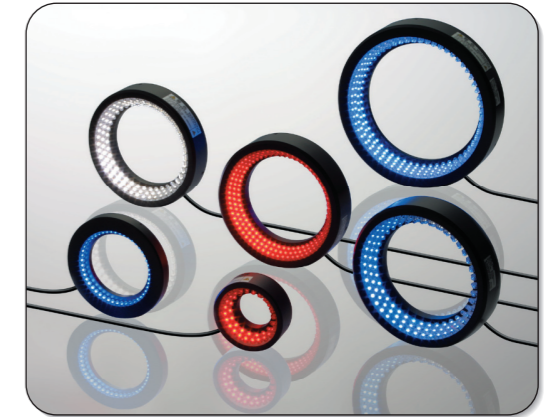

## List of Models

Model	Dimension	Luminescent Color	Max. rated current IFM (A)	Weight (g)	Power supply	Connection to strobe controller
MLRL-CR25	A	Red	0.15	70	080	○
*MLRL-CG25	A	Green	0.24		080	○
MLRL-CB25	A	Blue	0.24		080	○
MLRL-CW25	A	White	0.24		080	○
MLRL-CR46	B	Red	0.17	80	080	○
*MLRL-CG46	B	Green	0.27		080	○
MLRL-CB46	B	Blue	0.27		080	○
MLRL-CW46	B	White	0.27		080	○
MLRL-CR48	C	Red	0.30	110	080	○
*MLRL-CG48	C	Green	0.47		080	○
MLRL-CB48	C	Blue	0.47		080	○
MLRL-CW48	C	White	0.47		080	○
MLRL-CR68	D	Red	0.57	190	080	○
*MLRL-CG68	D	Green	0.61		080	○
MLRL-CB68	D	Blue	0.61		080	○
MLRL-CW68	D	White	0.61		080	○
MLRL-CR100	E	Red	0.96	320	230	×
*MLRL-CG100	E	Green	1.03		230	×
MLRL-CB100	E	Blue	1.03		230	×
MLRL-CW100	E	White	1.03		230	×

\* Production by order

## Options

Good for producing more uniform illumination than with direct lighting and for reducing glare and reflections.

### Diffusion ring

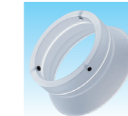

Model	Applicable model
MDF-LR25	MLRL-C (R,G,B,W) 25
MDF-LR48	MLRL-C (R,G,B,W) 48
MDF-LR68	MLRL-C (R,G,B,W) 68
MDF-LR100	MLRL-C (R,G,B,W) 100

## Dimensions

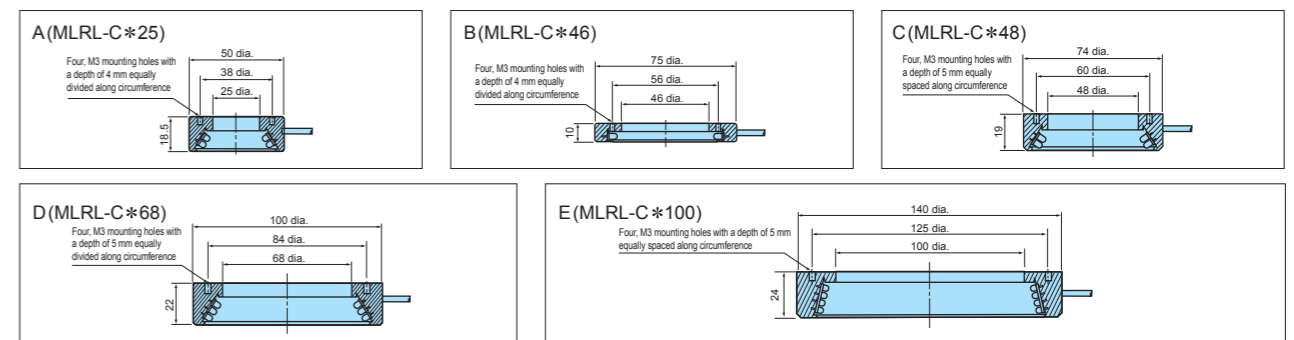



# Coaxial Light/Simulated Coaxial Episcopic Light

MCEL Series  
MSCL Series

## Model Number Legend

### Coaxial

3Z4S-LT MCEL-C \* ○ ○ ○ ○  
External diameter of the point  
Luminescent color (Red=R, Green=G, Blue=B, White=W)

### Simulated Coaxial

3Z4S-LT MSCL-C \* ○ ○ ○ ○ - \*  
Box height Revision code  
Luminescent color (Red=R, Green=G, Blue=B, White=W)

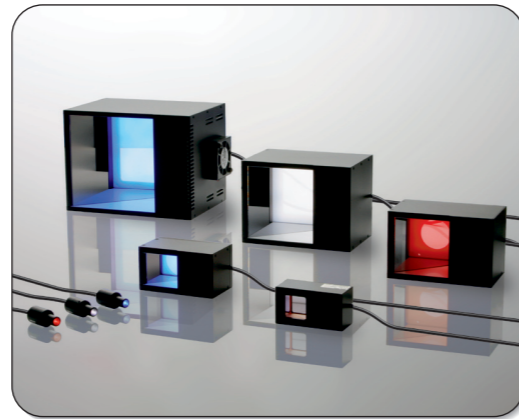

## List of Models

### Lineup of Coaxial Light

Model	Dimension	Luminescent Color	Max. rated current IFM (A)	Weight (g)	Power supply	Connection to strobe controller
MCEL-CR8	A	Red	0.04	35	080	×
MCEL-CG8	A	Green	0.03		080	×
MCEL-CB8	A	Blue	0.03		080	×
MCEL-CW8	A	White	0.03		080	×

### Lineup of Simulated Coaxial Episcopic Light

Model	Dimension	Luminescent Color	Max. rated current IFM (A)	Weight (g)	Power supply	Connection to strobe controller
MSCL-CR24	B	Red	0.09	110	080	○
* MSCL-CG24	B	Green	0.20		080	○
MSCL-CB24	B	Blue	0.20		080	○
MSCL-CW24	B	White	0.20		080	○
MSCL-CR39	C	Red	0.16	160	080	○
* MSCL-CG39	C	Green	0.31		080	○
MSCL-CB39	C	Blue	0.31		080	○
MSCL-CW39	C	White	0.31		080	○
MSCL-CR56-B	D	Red	0.33	320	080	○
* MSCL-CG56-B	D	Green	0.66		080	○
MSCL-CB56-B	D	Blue	0.66		080	○
MSCL-CW56-B	D	White	0.66		080	○
MSCL-CR74-B	E	Red	0.62	520	080	○
* MSCL-CG74-B	E	Green	1.11		230	×
MSCL-CB74-B	E	Blue	1.11		230	×
MSCL-CW74-B	E	White	1.11		230	×
MSCL-CR105-B*	F	Red	2.14	920	230	×
* MSCL-CG105-B*	F	Green	2.07		230	×
MSCL-CB105-B*	F	Blue	2.07		230	×
MSCL-CW105-B*	F	White	2.07		230	×

\*Always run the cooling fan to prevent heat build-up.

\*A Power Supply Extension Cable (M-RCB00-L) is required for the built-in fan. This is in addition to the normal Extension Cable. (Refer to page 26)

\*: Production by order

## Dimensions

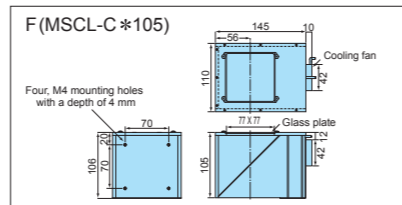
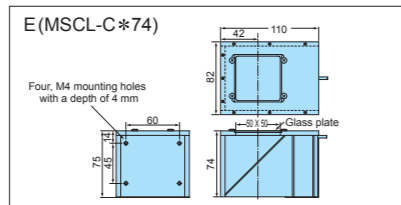
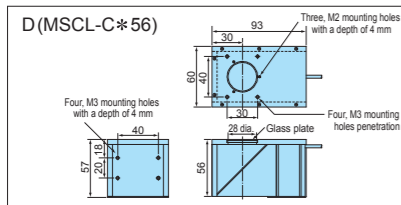
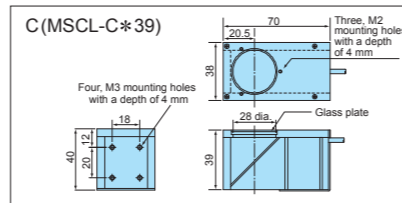
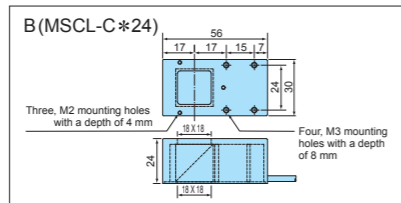
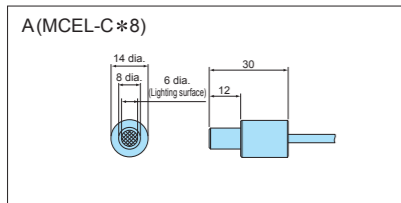

Standard cable length: 500 mm

# Shadowless Light

MSRL Series

MSLL Series

MSQL Series

## Model Number Legend

### Shadowless

3Z4S-LT MSRL-C \* ○ ○  
Internal diameter of the ring (mm)  
Luminescent color (Red=R, Green=G, Blue=B, White=W)

### Shadowless Low Angle Ring

3Z4S-LT MSLL-C \* ○ ○  
Internal diameter of the ring (mm)  
Luminescent color (Red=R, Green=G, Blue=B, White=W)

### Shadowless Low Angle Square

3Z4S-LT MSQL-C \* ○ ○  
External side dimension (mm)  
Luminescent color (Red=R, Green=G, Blue=B, White=W)

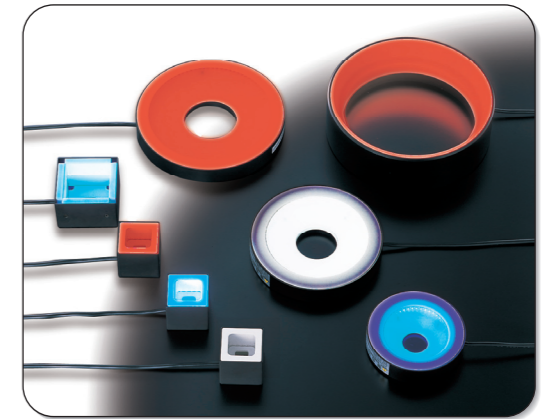

## List of Models

### Line up of Shadowless

Model	Dimension	Luminescent Color	Max. rated current IFM (A)	Weight (g)	Power supply	Connection to strobe controller
MSRL-CR20	A	Red	0.32	140	080	○
* MSRL-CG20	A	Green	0.50		080	○
MSRL-CB20	A	Blue	0.50		080	○
MSRL-CW20	A	White	0.50		080	○
MSRL-CR33	B	Red	0.45	210	080	○
* MSRL-CG33	B	Green	0.69		080	○
MSRL-CB33	B	Blue	0.69		080	○
MSRL-CW33	B	White	0.69		080	○
MSRL-CR44	C	Red	0.57	270	080	○
* MSRL-CG44	C	Green	0.80		080	○
MSRL-CB44	C	Blue	0.80		080	○
MSRL-CW44	C	White	0.80		080	○

### Line up of Shadowless Low Angle Ring

Model	Dimension	Luminescent Color	Max. rated current IFM (A)	Weight (g)	Power supply	Connection to strobe controller
MSLL-CR109	D	Red	0.62	320	080	○
* MSLL-CG109	D	Green	1.10		230	×
MSLL-CB109	D	Blue	1.10		230	×
MSLL-CW109	D	White	1.10		230	×

### Line up of Shadowless Low Angle Square

Model	Dimension	Luminescent Color	Max. rated current IFM (A)	Weight (g)	Power supply	Connection to strobe controller
MSQL-CR32	E	Red	0.09	80	080	○
* MSQL-CG32	E	Green	0.14		080	○
MSQL-CB32	E	Blue	0.14		080	○
MSQL-CW32	E	White	0.14		080	○
MSQL-CR48	F	Red	0.13	120	080	○
* MSQL-CG48	F	Green	0.20		080	○
MSQL-CB48	F	Blue	0.20		080	○
MSQL-CW48	F	White	0.20		080	○

\*: Production by order

## Dimensions

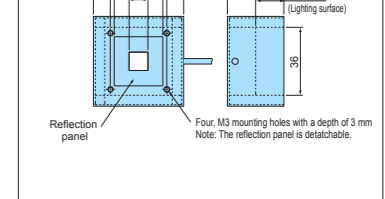
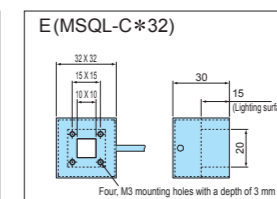
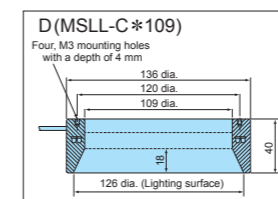
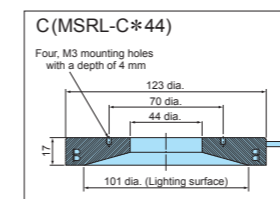
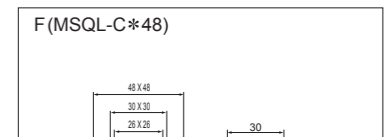
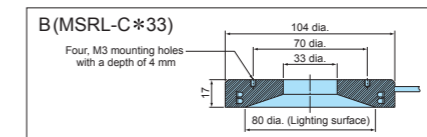
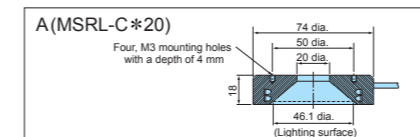

Mounting hole locations:

A to D: Equally spaced starting at a 45° offset from where the cable is connected to the unit. (Hole diameters, depths, and quantities are shown in the drawings.)

Standard cable length: 500 mm

# Bar Light/Line Light

MBRL Series

MLNL Series

## Model Number Legend

MBRL Series

3Z4S-LT MBRL-C \* ○ ○ ○ ○  
 Size (length and width)  
 Luminescent color (Red=R, Green=G, Blue=B, White=W)

MLNL Series

3Z4S-LT MLNL-C \* ○ ○ ○ ○  
 Line width  
 Luminescent color (Red=R, Green=G, Blue=B, White=W)

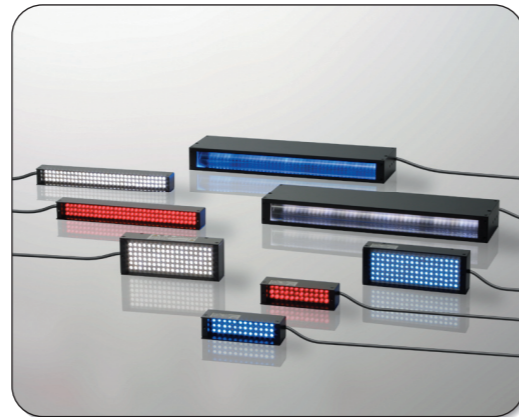

## List of Models

### Lineup of Bar Light

Model	Dimension	Luminescent Color	Max. rated current IFM (A)	Weight (g)	Power supply	Connection to strobe controller
MBRL-CR5015	A	Red	0.13	50	080	○
* MBRL-CG5015	A	Green	0.26		080	○
MBRL-CB5015	A	Blue	0.26		080	○
MBRL-CW5015	A	White	0.26	120	080	○
MBRL-CR7530	B	Red	0.36		080	○
* MBRL-CG7530	B	Green	0.52		080	○
MBRL-CB7530	B	Blue	0.52	85	080	○
MBRL-CW7530	B	White	0.52		080	○
MBRL-CR13015	C	Red	0.32		080	○
* MBRL-CG13015	C	Green	0.53	85	080	○
MBRL-CB13015	C	Blue	0.53		080	○
MBRL-CW13015	C	White	0.53		080	○

### Lineup of Line Light

Model	Dimension	Luminescent Color	Max. rated current IFM (A)	Weight (g)	Power supply	Connection to strobe controller
MLNL-CR192	D	Red	0.18	420	080	○
* MLNL-CG192	D	Green	0.36		080	○
MLNL-CB192	D	Blue	0.36		080	○
MLNL-CW192	D	White	0.36		080	○

\*: Production by order

## Dimensions

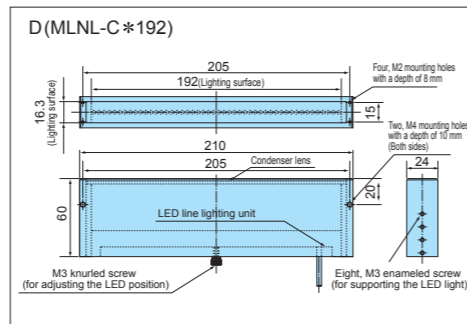
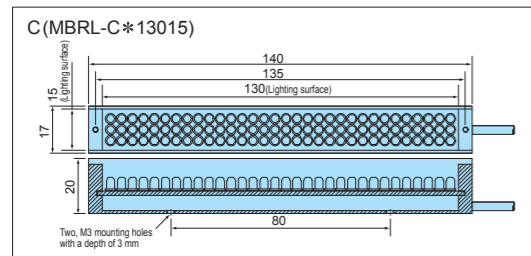
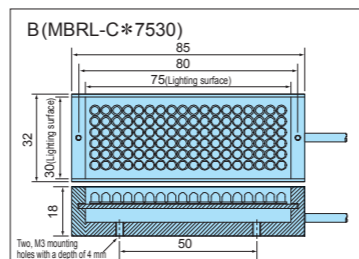
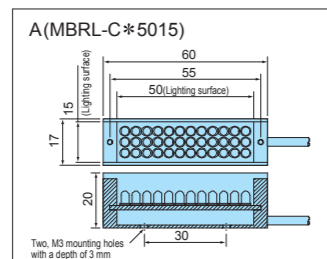

Mounting hole locations:  
 A to C: Arranged around the center of the mounting surface.

Standard cable length: 500 mm

# Dome Light

MDML Series

## Model Number Legend

3Z4S-LT MDML-C \* ○ ○ ○ ○  
 External size  
 Luminescent color (Red=R, Green=G, Blue=B, White=W)



## Dimensions

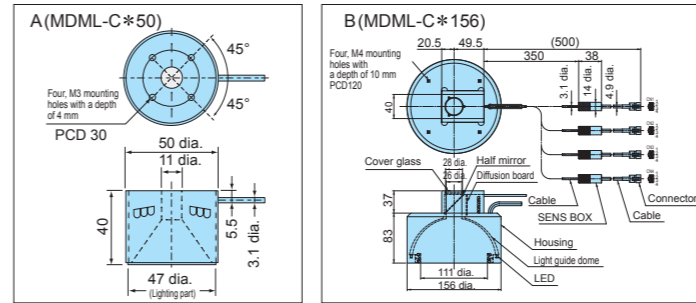

Standard cable length: 500 mm

## List of Models

Model	Dimension	Luminescent Color	Max. rated current IFM (A)	Weight (g)	Power supply	Connection to strobe controller
MDML-CR50	A	Red	0.24	130	080	○
* MDML-CG50	A	Green	0.37		080	○
MDML-CB50	A	Blue	0.37		080	○
MDML-CW50	A	White	0.37	1600	080	○
MDML-CR156	B	Red	1.16		230	×
MDML-CG156	B	Green	1.86		230	×
MDML-CB156	B	Blue	1.86	230	×	
MDML-CW156	B	White	1.86	230	×	

\*: Production by order

# High-powered Spot LED Light

MCEP Series

## Model Number Legend

3Z4S-LT MCEP-C \* 8  
 Luminescent color  
 (Red=R, Green=G, Blue=B, White=W)

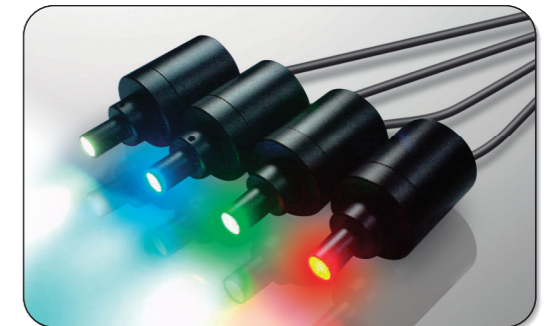

## Dimensions

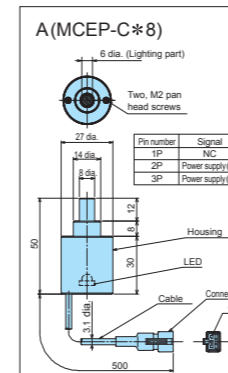

Standard cable length: 500 mm

## Removing the Point Rod

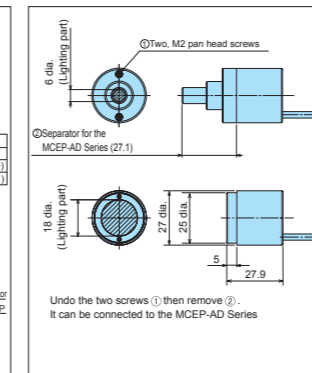

## List of Models

Model	Dimension	Luminescent Color	Dominant wavelength*	Color temperature	Max. rated current IFM (A)	Weight (g)	Connection to strobe controller
MCEP-CR8	A	Red	620.5~645nm	-	0.35	50	×
MCEP-CG8	A	Green	525~535nm	-	0.35		×
MCEP-CB8	A	Blue	470~480nm	-	0.35		×
MCEP-CW8	A	White	All	5000~6000K	0.35		×

\*The dominant wavelength of visible color according to CIE color coordinates. There are differences in the illuminated color for the dominant wavelengths of these LEDs. Colors may appear to be different even for the same model number.



# IR Light

MDRL Series  
MSRL Series  
MBRL Series  
MDBL Series

## Model Number Legend

3Z4S-LT M □ □ L - C IR ○ ○ ○ ○

DR=Direct ring  
SR=Shadowless ring  
BR=Bar  
DB=Direct backlight

See the explanation of each series model  
Luminescent color (IR: Infrared)



## List of Models

Model	Dimension	Luminescent Color	Max. rated current IFM (A)	Weight (g)	Power supply	Connection to strobe controller
MDRL-CIR31	A	Infrared	0.42	130	080	○
MSRL-CIR20	B	Infrared	0.36	140	080	○
MBRL-CIR7530	C	Infrared	0.40	120	080	○
MDBL-CIR70	D	Infrared	0.53	190	080	○

\*The dominant wavelength of visible color according to CIE color coordinates. There are differences in the illuminated color for the dominant wavelengths of these LEDs. Colors may appear to be different even for the same model number.

## Dimensions

A (MDRL-CIR31)

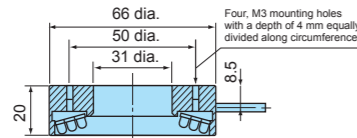

B (MSRL-CIR20)

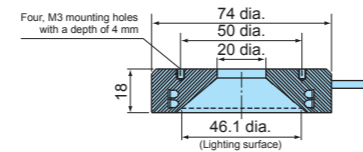

C (MBRL-CIR7530)

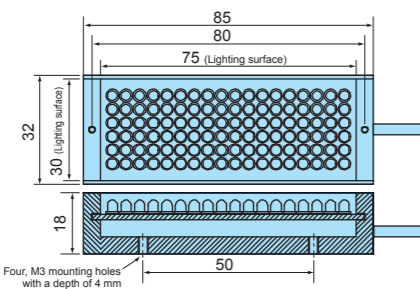

D (MDBL-CIR70)

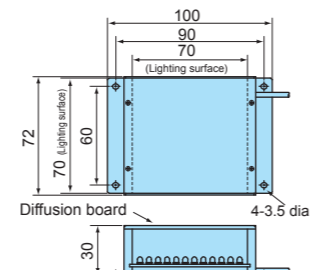

Mounting hole locations:  
A and B: Equally spaced starting at a 45° offset from where the cable is connected to the unit. (Hole diameters, depths, and quantities are shown in the drawings.)  
C: Arranged around the center of the mounting surface.

Standard cable length: 500 mm

# Direct Backlight

MDBL Series  
MDBC Series

## Model Number Legend

Shell type  
3Z4S-LT MDBL-C \* ○ ○ ○

Size (length and width)  
Luminescent color (Red=R, Green=G, Blue=B, White=W)

Chip mounting type  
3Z4S-LT MDBC-C \* ○ ○ ○

Chip type  
Size (length and width)  
Luminescent color (Red=R, Green=G, Blue=B, White=W)

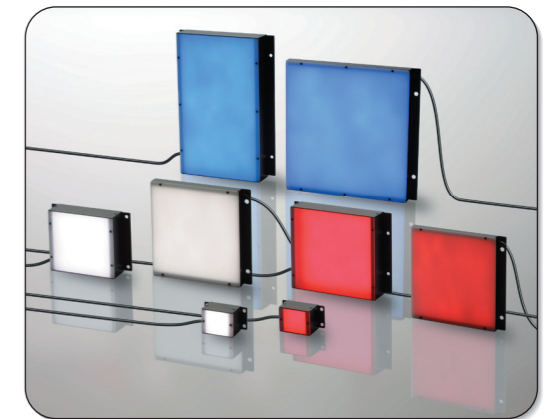

## List of Models

### Lineup of Shell type

Model	Dimension	Luminescent Color	Max. rated current IFM (A)	Weight (g)	Power supply	Connection to strobe controller
MDBL-CR25	A	Red	0.14	60	080	○
* MDBL-CG25	A	Green	0.27		080	○
MDBL-CB25	A	Blue	0.27		080	○
MDBL-CW25	A	White	0.27		080	○
MDBL-CR70	B	Red	0.48	190	080	○
* MDBL-CG70	B	Green	0.96		230	×
MDBL-CB70	B	Blue	0.96		230	×
MDBL-CW70	B	White	0.96		230	×
MDBL-CR100	C	Red	1.43	290	230	×
* MDBL-CG100	C	Green	1.55		230	×
MDBL-CB100	C	Blue	1.55		230	×
MDBL-CW100	C	White	1.55		230	×
MDBL-CR180100	D	Red	2.30	520	230	×
* MDBL-CG180100	D	Green	2.30		230	×
MDBL-CB180100	D	Blue	2.30		230	×
MDBL-CW180100	D	White	2.30		230	×

### Lineup of Chip mounting type

Model	Dimension	Luminescent Color	Max. rated current IFM (A)	Weight (g)	Power supply	Connection to strobe controller
MDBC-CR100	E	Red	0.81	170	230	×
* MDBC-CG100	E	Green	0.95		230	×
MDBC-CB100	E	Blue	0.95		230	×
MDBC-CW100	E	White	0.95		230	×
MDBC-CR150	F	Red	0.99	310	230	×
* MDBC-CG150	F	Green	2.14		230	×
MDBC-CB150	F	Blue	2.14		230	×
MDBC-CW150	F	White	2.14		230	×

\*: Production by order

## Dimensions

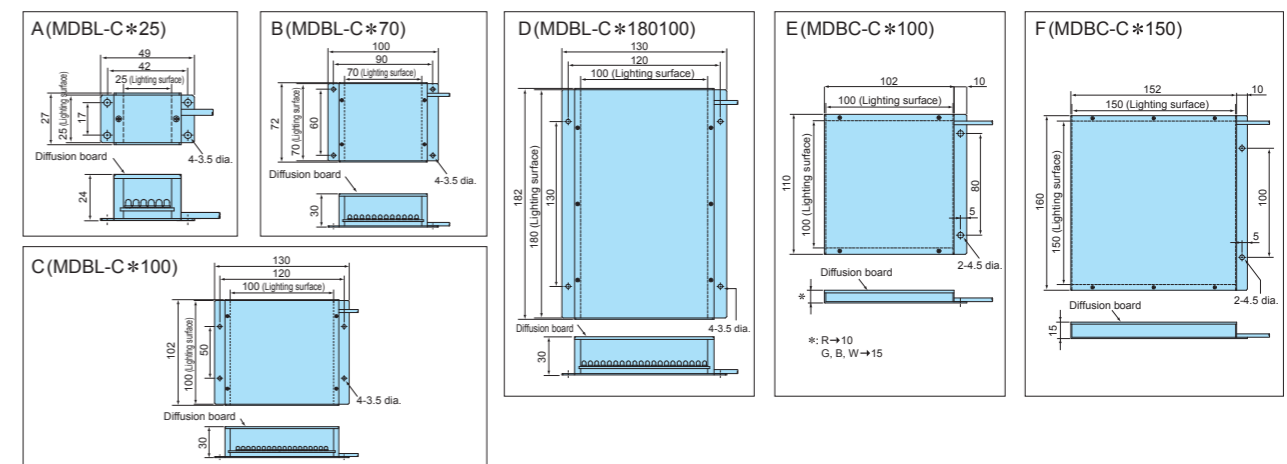

Standard cable length: 500 mm

# Edge-type Backlight

## Model Number Legend

3Z4S-LT MEBL-C \* ○ ○ ○ ○  
 Luminescent color (Red=R, Green=G, Blue=B, White=W)  
 Size (length and width)

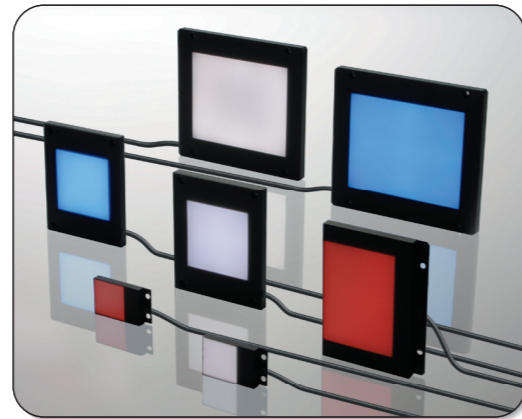

## List of Models

Model	Dimension	Luminescent Color	Max. rated current IFM (A)	Weight (g)	Power supply	Connection to strobe controller
MEBL-CR25	A	Red	0.03	45	080	○
* MEBL-CG25	A	Green	0.04		080	○
MEBL-CB25	A	Blue	0.04		080	○
MEBL-CW25	A	White	0.04		080	○
MEBL-CR50	B	Red	0.17	110	080	○
* MEBL-CG50	B	Green	0.29		080	○
MEBL-CB50	B	Blue	0.29		080	○
MEBL-CW50	B	White	0.29		080	○
MEBL-CR7050	C	Red	0.15	140	080	○
* MEBL-CG7050	C	Green	0.25		080	○
MEBL-CB7050	C	Blue	0.25		080	○
MEBL-CW7050	C	White	0.25		080	○
MEBL-CR10080	D	Red	0.32	230	080	○
* MEBL-CG10080	D	Green	0.57		080	○
MEBL-CB10080	D	Blue	0.57		080	○
MEBL-CW10080	D	White	0.57		080	○
MEBL-CR145	E	Red	0.45	460	080	○
* MEBL-CG145	E	Green	0.8		080	○
MEBL-CB145	E	Blue	0.8		080	○
MEBL-CW145	E	White	0.8		080	○

\*: Production by order

## Dimensions

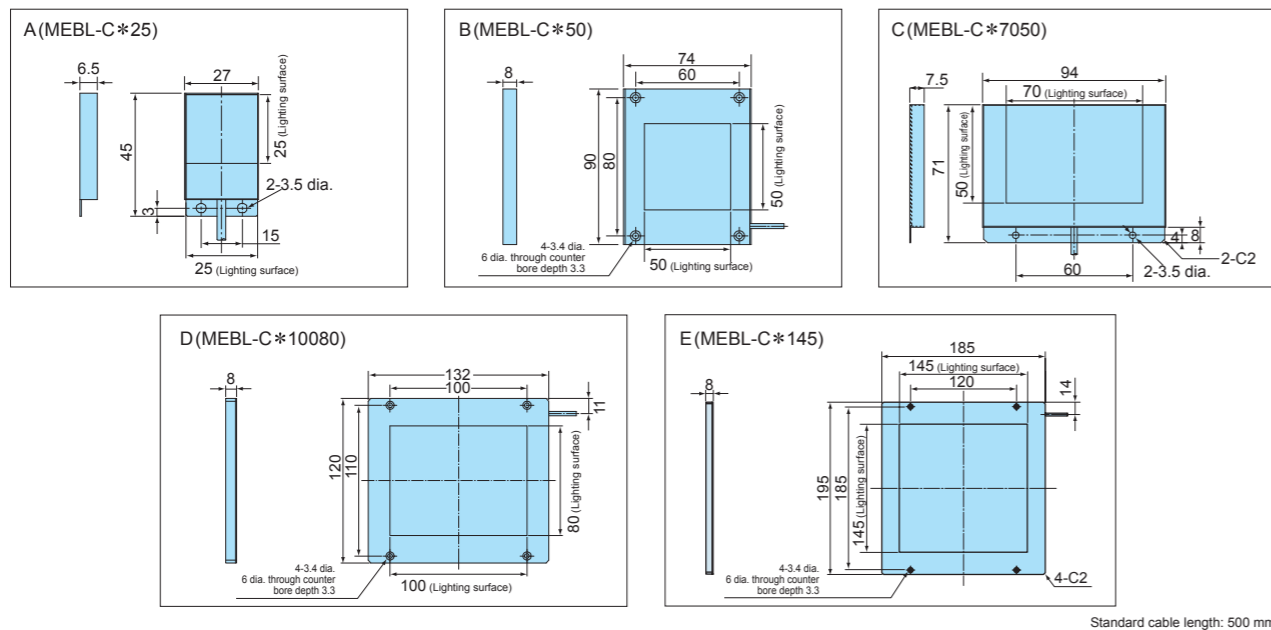

# Square Oblique Light

## Model Number Legend

3Z4S-LT MDQL-C \* ○ ○ ○ ○  
 Luminescent color (Red=R, Green=G, Blue=B, White=W)  
 External size

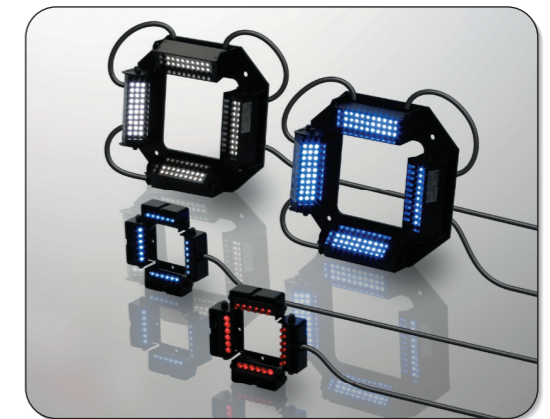

## List of Models

Model	Dimension	Luminescent Color	Max. rated current IFM (A)	Weight (g)	Power supply	Connection to strobe controller
MDQL-CR58	A	Red	0.09	55	080	○
* MDQL-CG58	A	Green	0.17		080	○
MDQL-CB58	A	Blue	0.17		080	○
MDQL-CW58	A	White	0.17		080	○
MDQL-CR108	B	Red	0.42	210	080	○
* MDQL-CG108	B	Green	0.84		230	×
MDQL-CB108	B	Blue	0.84		230	×
MDQL-CW108	B	White	0.84		230	×

\*: Production by order

## Dimensions

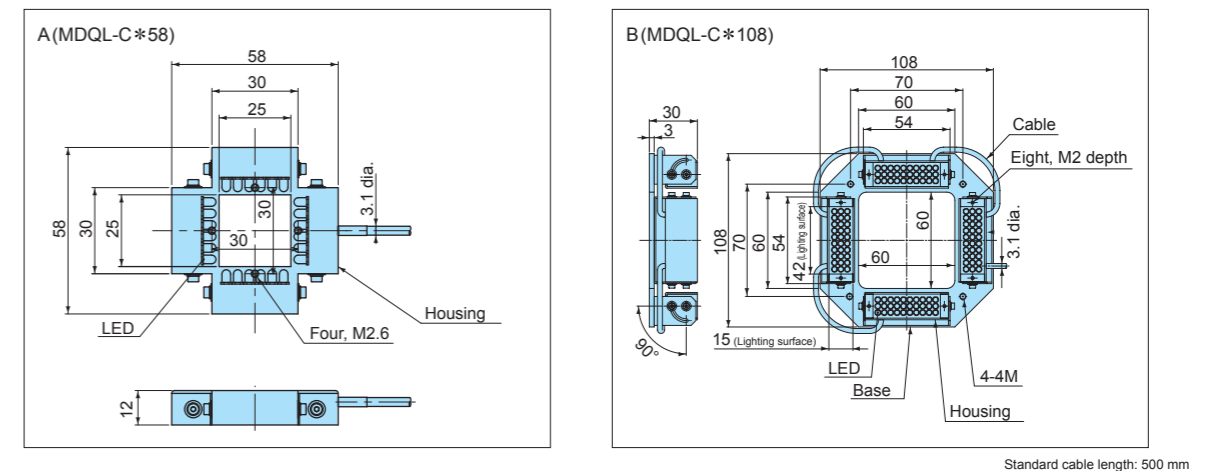



# UV Light

MDRL Series

MBRL Series

MDQL Series

## Model Number Legend

3Z4S-LT M □ □ L - C UV ○ ○ ○ ○

DR=Direct ring  
BR=Bar  
DQ=Square oblique

See the explanation of each series model.  
Luminescent color (Ultra violet=UV)

## List of Models

Model	Dimension	Luminescent Color	Max. rated current IFM (A)	Weight (g)	Power supply	Connection to strobe controller
MDRL-CUV31	A	Ultraviolet	0.36	130	080	○
MBRL-CUV7530	B	Ultraviolet	0.36	120	080	○
MDQL-CUV108	C	Ultraviolet	0.36	210	080	○

## Dimensions

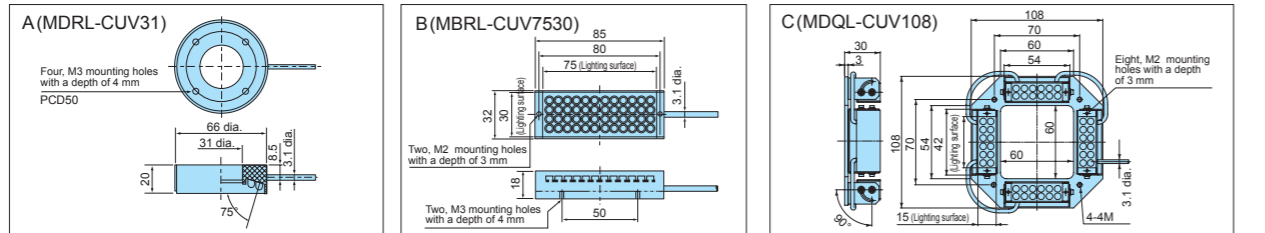

Mounting hole locations:  
A: Equally spaced starting at a 45° offset from where the cable is connected to the unit. (Hole diameters, depths, and quantities are shown in the drawings.)  
B: Arranged around the center of the mounting surface.  
Standard cable length: 500 mm

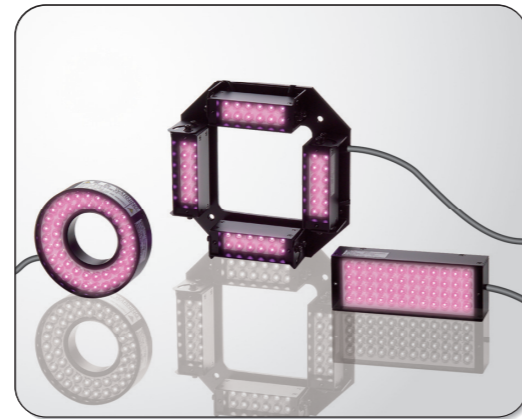

# Spot Led Light

MSPP Series  
(CE Marking)

## Model Number Legend

3Z4S-LT MSPP-C \* ○ ○

Effective size (Lighting part)  
Luminescent color (Red=R, White=W)

## List of Models

### Wide projection

Model	Dimension	Luminescent Color	Max. rated current IFM (A)	Weight (g)	Power supply	Connection to strobe controller
MSPP-CR42	A	Red	0.7	460g	MLEP-A070 series	×
MSPP-CW42	A	White	0.7	460g	MLEP-A070 series	×

### Narrow projection

Model	Dimension	Luminescent Color	Max. rated current IFM (A)	Weight (g)	Power supply	Connection to strobe controller
MSPP-CR74	B	Red	0.7	600g	MLEP-A070 series	×
MSPP-CW74	B	White	0.7	600g	MLEP-A070 series	×

\*Always connect a Conversion Cable (3Z4S-LT M-RCB301XS) when connecting the power supply.

## Dimensions

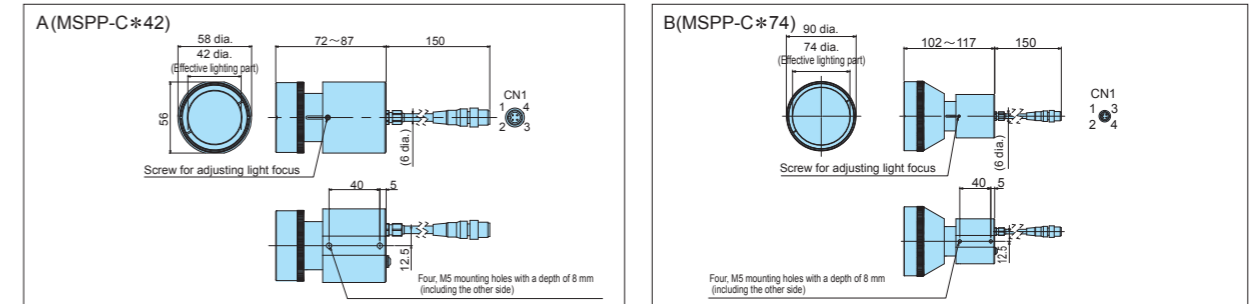

# Parallel Light

MCBP Series

## Model Number Legend

3Z4S-LT MCBP-C \* ○ ○ ○ ○

Size (length and width)  
Luminescent color (Red=R, White=W)

## List of Models

Model	Dimension	Luminescent Color	Max. rated current IFM (A)	Weight (g)	Power supply	Connection to strobe controller
★ MCBP-CG3430	A	Green	0.07	260	080	×
MCBP-CB3430	A	Blue	0.07		080	×
MCBP-CW3430	A	White	0.07		080	×

\*: Production by order

## Dimensions

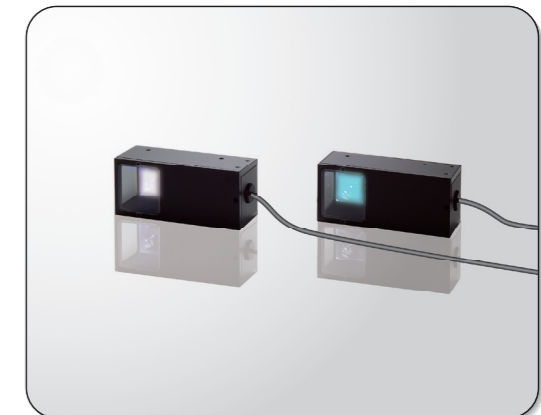
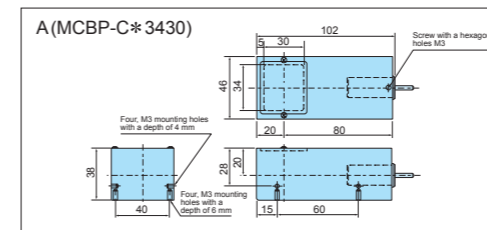

# CCTV Lens

ML Series



## List of Models

Model	Dimension	Focal distance f (mm)	Focus (F No.)	Field of view (V X H)	Closest distance (m)	Filter screw	Weight (g)	Total length A (mm)	Maximum compatible CCD	Camera Mount
3Z4S-LE ML-0614	A	6	F1.4~Close	42.3°×54.6°	0.2	M27 P0.5	60	30	1/2 Inch	C-Mount
3Z4S-LE ML-0813	B	8	F1.3~Close	45.0°×57.8°	0.3	M25.5 P0.5		34.5	2/3 Inch	
3Z4S-LE ML-1214	C	12	F1.4~Close	21.9°×29.0°	0.4	M27 P0.5		40	1/2 Inch	
3Z4S-LE ML-1614	D	16		23.0°×30.4°				2/3 Inch		
3Z4S-LE ML-2514	E	25	F1.9~Close	21.6°×28.5°	0.5	M30.5 P0.5	45	1 Inch		
3Z4S-LE ML-3519	F	35	F1.9~Close	10.8°×14.4°	1		50	29	2/3 Inch	
3Z4S-LE ML-5018	G	50	F1.8~Close	7.9°×10.5°		60	37			
3Z4S-LE ML-7527	H	75	F2.7~Close	4.9°×6.5°		65	42.5			
3Z4S-LE ML-10035		100	F3.5~Close	3.8°×5.1°		43.9				

## Dimensions

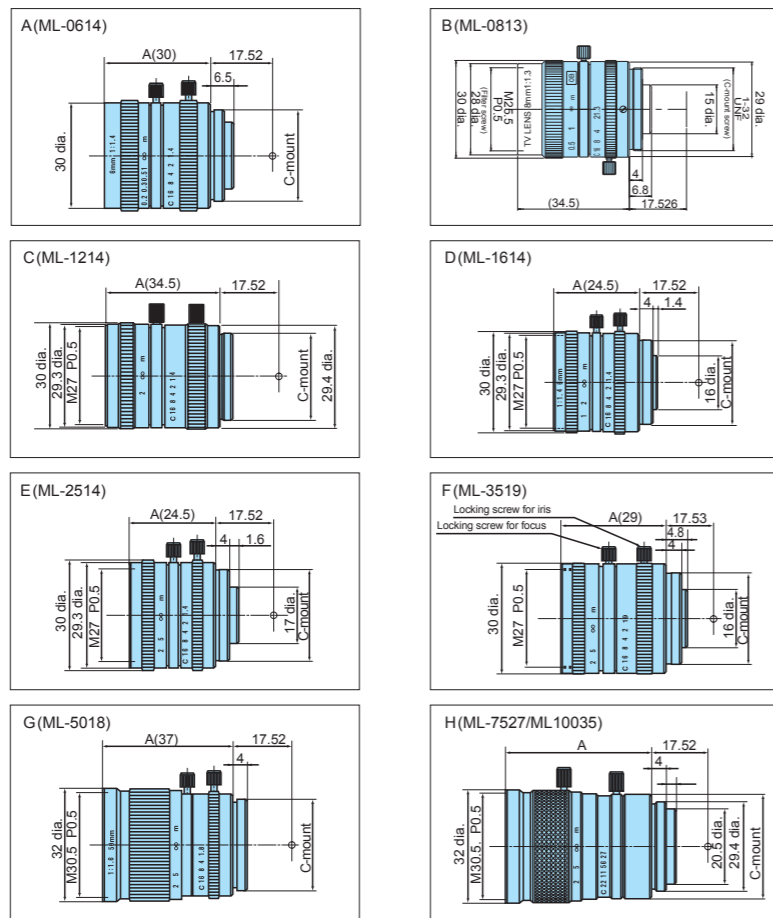

# CCTV Lens Option

ML Series

## Polarizing Filter

Model
3Z4S-LE ML-PL270
3Z4S-LE ML-PL255
3Z4S-LE ML-PL305



## Close-up Ring

Model	Length (mm)
3Z4S-LE ML-EXR*	7-piece set (0.5, 1, 2, 5, 10, 20, 40)
3Z4S-LE ML-EXR1520	Variable
3Z4S-LE ML-EXR3042	Variable



\*These Close-up Rings are also available individually. Order using the following model number, replacing the box with the desired length: 3Z4S-LE ML-EXR□. Inquire concerning prices.

## Rear Converter Lens

### Configuration

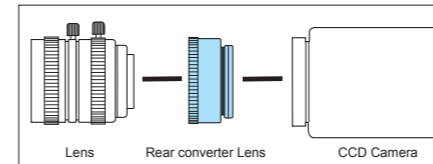

### List of Models

Model
3Z4S-LE ML-1.5X
3Z4S-LE ML-2X
3Z4S-LE ML-2.5X
3Z4S-LE ML-3X
3Z4S-LE ML-4X



# Non-telecentric Macro Lens

ML-N Series

## List of Models

Model	Dimension	Magnification	Effective FNO	O/I (mm)	WD (mm)	Depth of field*	Resolution	TV distortion
3Z4S-LE ML01-327N	A	0.1	4.71	364.5	327.7	37.66mm	33.9μm	0.4% max.
3Z4S-LE ML03-181N	B	0.3	6.11	240.9	181.3	5.43mm	14.6μm	0.2% max.
3Z4S-LE ML05-132N	C	0.5	6.08	199	132.5	1.95mm	11.7μm	0.08% max.
3Z4S-LE ML1-89N	D	1.0	8.82	177.5	89.6	0.7mm	7.9μm	0.04% max.

\*The field of depth is calculated based on an image equivalent to 320 horizontal TV lines taken with a 1/2" CCD camera.

## Dimensions

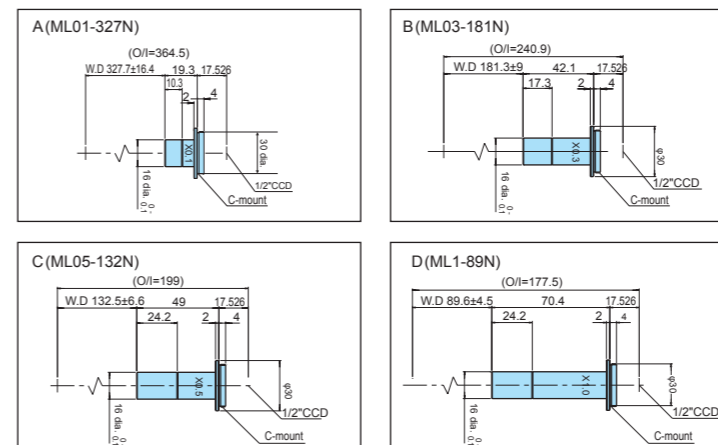

Non-telecentric Macro Lens



# New Power Supplies for MCEP/MSPP Series

These constant-current power supplies are designed specifically for the MCEP Series of High-power LED Spot Lights and MSPP Series of LED Spot Lights.

## Model Number Legend

3Z4S-LT MLEP-A \*\*\*W\*LR\* - \*\*\*V  
 Maximum output current    Output channel    AC type    Digital type (D)



## NEW MLEP Analog Series

Models are available with an analog light adjustment and for either one or three channels. A wide voltage input (100 to 240 VAC) is supported, along with CE Marking.

### Ratings and Specifications

Model	MLEP-A035W 1LR-100V	MLEP-A035W1 LR-200V	MLEP-A070W1 LR-100V	MLEP-A070W1 LR-200V	MLEP-A035W3 LR-100V	MLEP-A035W3 LR-200V	MLEP-A070W3 LR-100V	MLEP-A070W3 LR-200V
AC Type	100V	200V	100V	200V	100V	200V	100V	200V
Output	Single-channel out put max.350 mA		Single-channel out put max.700 mA		3-channel out put for each channel max.350 mA		3-channel out put for each channel max.700 mA	
Dimension	A				B			
Input voltage	100 - 240V AC 50 / 60Hz				100 - 240V AC 50 / 60Hz			
Input current	0.35 / 0.25A (at AC 100/240V)				0.35/0.25 A (at AC 100/240V)			
Surge current	20A or lower (at 100V AC) 40A or lower (at 240V AC)				20A or lower (at 100V AC) 40A or lower (at 240V AC)			
Operating temperature	0 to +45°C				0 to +45°C			
Output system	Continuous DC output				Continuous DC output			
Output control system	Constant current control (the current can be changed)				Constant current control (the current can be changed)			
External light control	Supported (0 to 5V)				Supported (0 to 5V)			
Lighting on/off function	Supported (photocoupler insulation)				Supported (photocoupler insulation)			
Cooling system	Natural air cooling				forcible air cooling			
Installation	Horizontal installation on the rubber supports at the bottom of the unit				Horizontal installation on the rubber supports at the bottom of the unit			
Weight	Approximately 0.9kg				Approximately 1.4kg			

### Connection Specifications

### I/O Circuit Diagrams

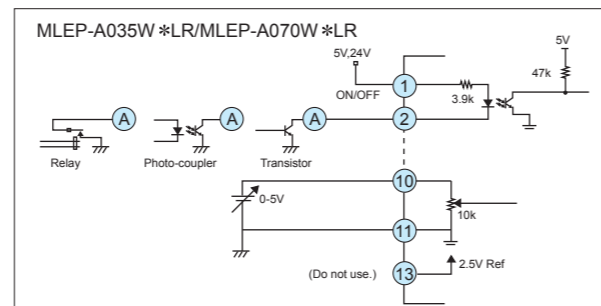
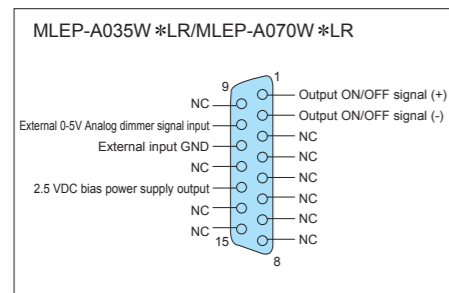

### Dimensions

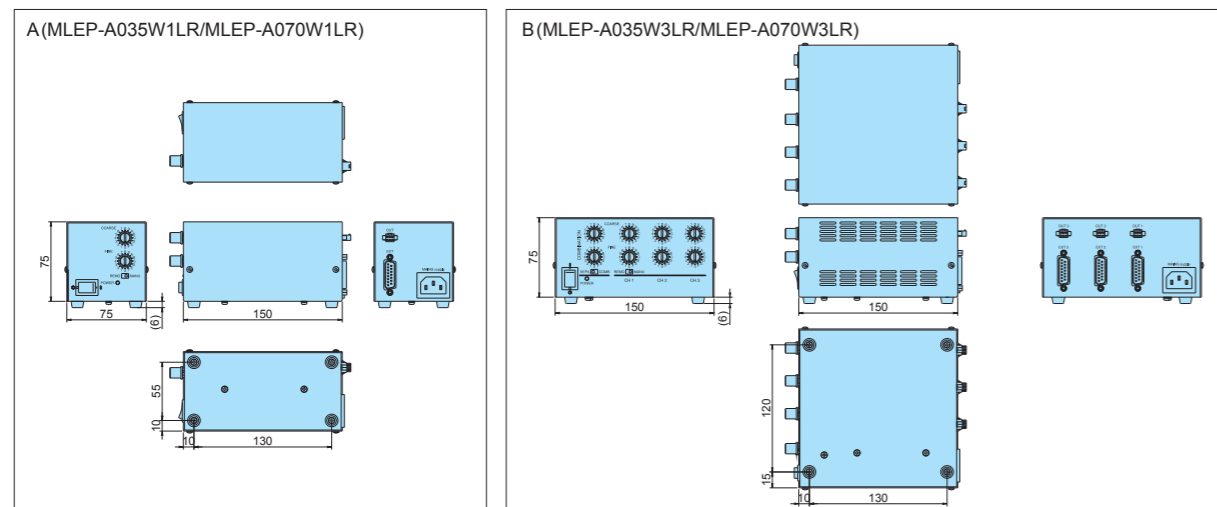

## NEW MLEP Digital Series

Models are available with a digital light adjustment and for either one or three channels. A wide voltage input (100 to 240 VAC) is supported, along with CE Marking.

### Ratings and Specifications

Model	MLEP-A035W1 LRD-100V	MLEP-A035W1 LRD-200V	MLEP-A070W1 LRD-100V	MLEP-A070W1 LRD-200V	MLEP-A035W3 LRD-100V	MLEP-A035W3 LRD-200V	MLEP-A070W3 LRD-100V	MLEP-A070W3 LRD-200V
AC Type	100V	200V	100V	200V	100V	200V	100V	200V
Output	Single-channel out put max.350 mA		Single-channel out put max.700 mA		3-channel out put for each channel max.350 mA		3-channel out put for each channel max.700 mA	
Dimension	A				B			
Input voltage	100 - 240V AC 50 / 60Hz				100 - 240V AC 50 / 60Hz			
Input current	0.35 / 0.25A (at AC 100/240V)				0.35/0.25 A (at AC 100/240V)			
Surge current	20A or lower (at 100V AC) 40A or lower (at 240V AC)				20A or lower (at 100V AC) 40A or lower (at 240V AC)			
Operating temperature	0 to +45°C				0 to +45°C			
Output system	Continuous DC output				Continuous DC output			
Output control system	Constant current control (the current can be changed)				Constant current control (the current can be changed)			
External light control	Supported (8bit digital)				Supported ( for each channel, 8bit digital)			
Lighting on/off function	Supported (photocoupler insulation)				Supported (photocoupler insulation)			
Cooling system	Natural air cooling				forcible air cooling			
Installation	Horizontal installation on the rubber supports at the bottom of the unit				Horizontal installation on the rubber supports at the bottom of the unit			
Weight	Approximately 0.9kg				Approximately 1.4kg			

### Connection Specifications

### I/O Circuit Diagrams

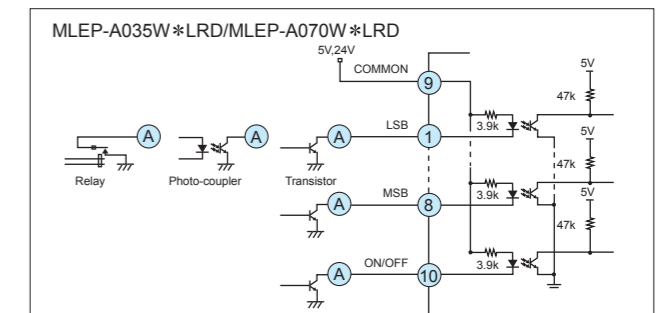
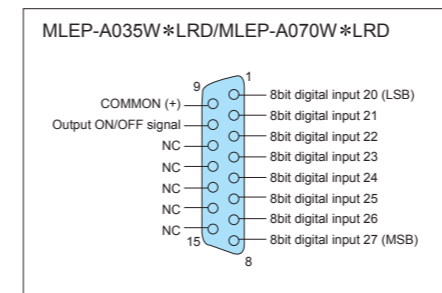

### Dimensions

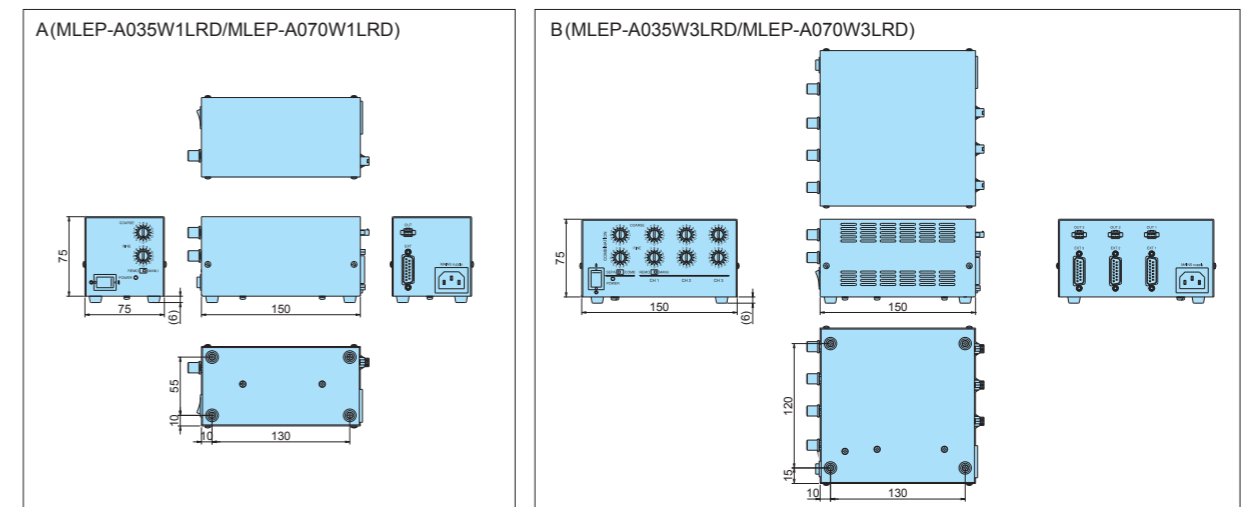

# New Power Supplies for MG-Wave Series

These new power supplies are designed specifically for Moritex Constant-current LED Lights (except for the MCEP Series). Even when combining with an LED Light from the broad lineup and possible applications, you can select the ideal Constant-current Power Supply for the required current consumption. The Power Supplies suppress heat generation and will make the most of the characteristics of any of the LED Light. External output controls and other features are also provided.

## Model Number Legend

**3Z4S-LT MLEK-A \*\*\*W\*LR\* - \*\*\*V**

Maximum output current | Output channel | Digital type (D)



### A080/230W Analog Series (Total current: 0.8 A or 2.3 A)

Models are available with an analog light adjustment and for either one or two channels. A wide voltage input (100 to 240 VAC) is supported, along with CE Marking.

#### Ratings and Specifications

Model	MLEK-A080W1LR-100V	MLEK-A080W1LR-200V	MLEK-A080W2LR-100V	MLEK-A080W2LR-200V
AC Type	100V	200V	100V	200V
Output	Single-channel output of 0.8A (for connection to all lights except the MCEP Series)		Two-channel maximum, output of 0.8A for each channel (for connection to all lights except the MCEP Series)	
Input voltage	100 - 240V AC 50 / 60Hz		100 - 240V AC 50 / 60Hz	
Dimension	A		B	
Input current	0.3 / 0.15A (at AC 100/240V)		0.3 / 0.15A (at AC 100/240V)	
Surge current	15A or lower (at 100V AC) 35A or lower (at 240V AC)		15A or lower (at 100V AC) 35A or lower (at 240V AC)	
Operating temperature	0 to +45°C		0 to +45°C	
Output system	Continuous DC output		Continuous DC output	
Output control system	Constant current control (the current can be changed)		Constant current control (the current can be changed)	
External light control	Supported (0 to 5V)		Supported (0 to 5V)	
Lighting on/off function	Supported (photocoupler insulation)		Supported (photocoupler insulation)	
Error output	Supported (photocoupler insulation, control error)		Supported (photocoupler insulation, control error)	
Cooling system	Natural air cooling		Natural air cooling	
Installation	Horizontal installation on the rubber supports at the bottom of the unit		Horizontal installation on the rubber supports at the bottom of the unit	
Weight	Approximately 1kg		Approximately 1.3kg	

### A080/230W Digital Series (Total current: 0.8 A or 2.3 A)

Models are available with a digital light adjustment and for either one or two channels. A wide voltage input (100 to 240 VAC) is supported, along with CE Marking.

#### Ratings and Specifications

Model	MLEK-A080W1LRD-100V	MLEK-A080W1LRD-200V	MLEK-A080W2LRD-100V	MLEK-A080W2LRD-200V
AC Type	100V	200V	100V	200V
Output	Single-channel output of 0.8A (for connection to all lights except the MCEP Series)		Two-channel maximum, output of 0.8A for each channel (for connection to all lights except the MCEP Series)	
Input voltage	100 - 240V AC 50 / 60Hz		100 - 240V AC 50 / 60Hz	
Dimension	A		B	
Input current	0.3 / 0.15A (at AC 100/240V)		0.3 / 0.15A (at AC 100/240V)	
Surge current	15A or lower (at 100V AC) 35A or lower (at 240V AC)		15A or lower (at 100V AC) 35A or lower (at 240V AC)	
Operating temperature	0 to +45°C		0 to +45°C	
Output system	Continuous DC output		Continuous DC output	
Output control system	Constant current control (the current can be changed)		Constant current control (the current can be changed)	
External light control	Supported (8bit digital)		Supported (for each channel, 8bit digital)	
Lighting on/off function	Supported (photocoupler insulation)		Supported (photocoupler insulation)	
Error output	Supported (photocoupler insulation, control error)		Supported (photocoupler insulation, control error)	
Cooling system	Natural air cooling		Natural air cooling	
Installation	Horizontal installation on the rubber supports at the bottom of the unit		Horizontal installation on the rubber supports at the bottom of the unit	
Weight	Approximately 1kg		Approximately 1.3kg	

Model	MLEK-A230W1LR-100V	MLEK-A230W1LR-200V	MLEK-A230W2LR-100V	MLEK-A230W2LR-200V
AC Type	100V	200V	100V	200V
Output	Single-channel output of 2.3A (for connection to all lights except the MCEP Series)		Two-channel maximum, output of 2.3A for each channel (for connection to all lights except the MCEP Series)	
Input voltage	100 - 240V AC 50 / 60Hz		100 - 240V AC 50 / 60Hz	
Dimension	A		B	
Input current	0.7 / 0.4A (at AC 100/240V)		0.7 / 0.4A (at AC 100/240V)	
Surge current	15A or lower (at 100V AC) 35A or lower (at 240V AC)		15A or lower (at 100V AC) 35A or lower (at 240V AC)	
Operating temperature	0 to +45°C		0 to +45°C	
Output system	Continuous DC output		Continuous DC output	
Output control system	Constant current control (the current can be changed)		Constant current control (the current can be changed)	
External light control	Supported (0 to 5V dimmer signal / External VR input)		Supported (0 to 5V dimmer signal / External VR input)	
Lighting on/off function	Supported (photocoupler insulation)		Supported (photocoupler insulation)	
Error output	Supported (photocoupler insulation, control error)		Supported (photocoupler insulation, control error)	
Cooling system	forcible air cooling		forcible air cooling	
Installation	Horizontal installation on the rubber supports at the bottom of the unit		Horizontal installation on the rubber supports at the bottom of the unit	
Weight	Approximately 1.1kg		Approximately 1.4kg	

Model	MLEK-A230W1LRD-100V	MLEK-A230W1LRD-200V	MLEK-A230W2LRD-100V	MLEK-A230W2LRD-200V
AC Type	100V	200V	100V	200V
Output	Single-channel output of 2.3A (for connection to all lights except the MCEP Series)		Two-channel maximum, output of 2.3A for each channel (for connection to all lights except the MCEP Series)	
Input voltage	100 - 240V AC 50 / 60Hz		100 - 240V AC 50 / 60Hz	
Dimension	A		B	
Input current	0.7 / 0.4A (at AC 100/240V)		0.7 / 0.4A (at AC 100/240V)	
Surge current	15A or lower (at 100V AC) 35A or lower (at 240V AC)		15A or lower (at 100V AC) 35A or lower (at 240V AC)	
Operating temperature	0 to +45°C		0 to +45°C	
Output system	Continuous DC output		Continuous DC output	
Output control system	Constant current control (the current can be changed)		Constant current control (the current can be changed)	
External light control	Supported (8bit digital)		Supported (for each channel, 8bit digital)	
Lighting on/off function	Supported (photocoupler insulation)		Supported (photocoupler insulation)	
Error output	Supported (photocoupler insulation, control error)		Supported (photocoupler insulation, control error)	
Cooling system	forcible air cooling		forcible air cooling	
Installation	Horizontal installation on the rubber supports at the bottom of the unit		Horizontal installation on the rubber supports at the bottom of the unit	
Weight	Approximately 1.1kg		Approximately 1.4kg	

#### Connection Specifications

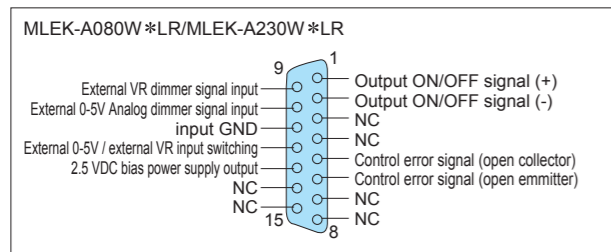

#### I/O Circuit Diagrams

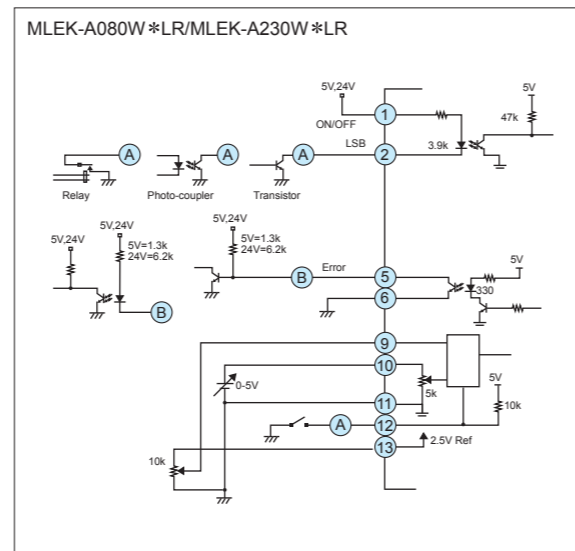

#### Dimensions

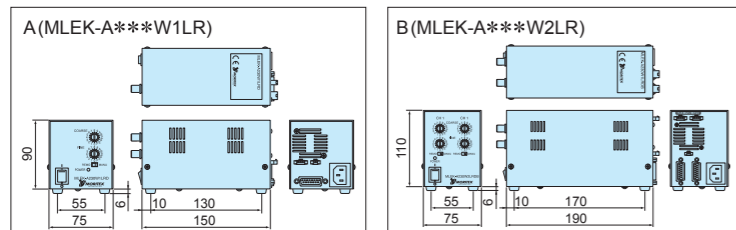

#### Connection Specifications

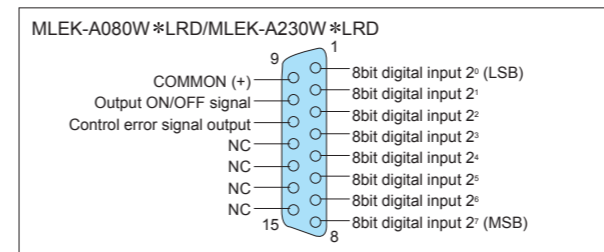

#### I/O Circuit Diagrams

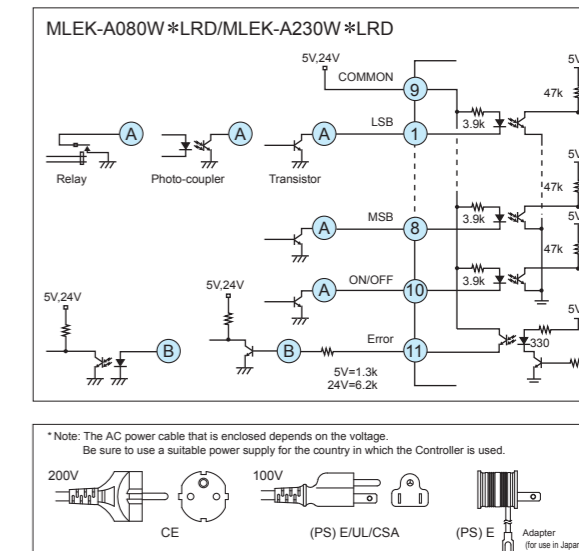

#### Dimensions

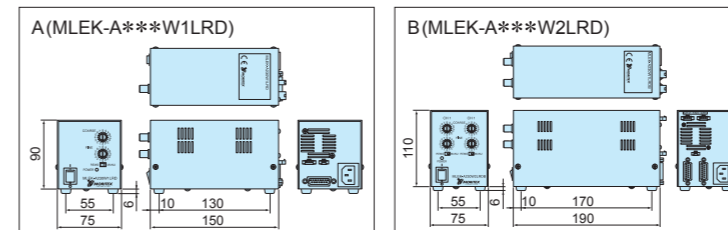



Model Number Legend Multichannel series

3Z4S-LT MLEK- D770W4LRD- \*\*\* V  
AC type

Multichannel series

Models are available with a digital light adjustment and for four channels. A wide voltage input (100 to 240 VAC) is supported, along with Rohs compliance. The digital light adjustment provides the previous 8-bit, 256-step control and a new 10-bit, 1,024-step control.

\*CE Marking.



Ratings and Specifications

Model	MLEK-D770W4LRD-100V	MLEK-D770W4LRD-200V
AC Type	100V	200V
Output	4-channel output Total max. 7.7A (CH1~ CH3:max. 2.3A CH4:max. 0.8A) (for connection to all lights except the MCEP Series)	
Input voltage	100 - 240V AC 50 / 60Hz	
Dimension	A	
Input current	1.7/0.8 A (at AC 100/240V)	
Surge current	18A or lower (at 100V AC) 41A or lower (at 230V AC)	
Operating temperature	0 to +45°C	
Output system	Continuous DC output	
Output control system	Constant current control (the current can be changed)	
External light control	Supported ( for each channel, 8bit digital or 10 bit digital)	
Lighting on/off function	Supported (photocoupler insulation)	
Error output	Supported (photocoupler insulation, control error)	
Cooling system	forcible air cooling	
Installation	Horizontal installation on the rubber supports at the bottom of the unit	
Weight	Approximately 2kg	

Connection Specifications

I/O Circuit Diagrams

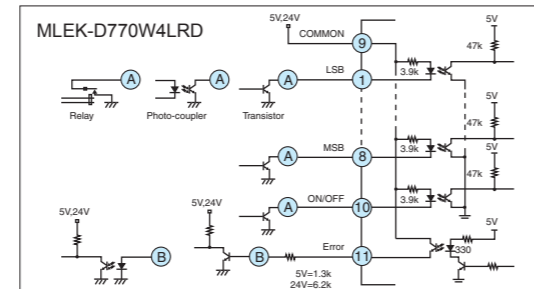
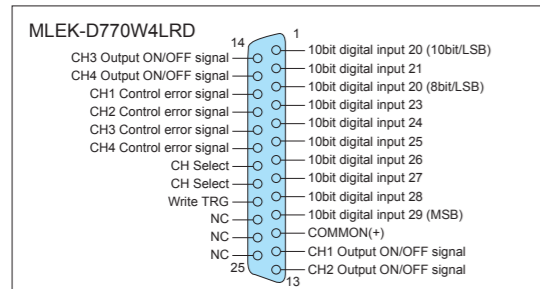

Dimensions

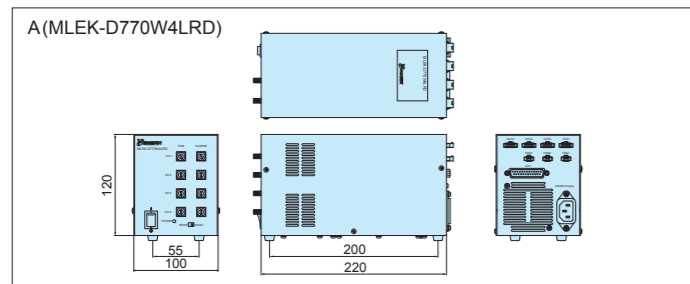

Optional Accessories

\*When ordering, provide the specific model number after "SZ4S-LT" (example: SZ4S-LT MDF-DR10).

Options for lights

The following optional accessories are available to improve the functionality of the lighting devices.

Diffusion plate:MDF Series

The MDF series features a diffusion plate that increases the light diffusion and reduces reflection and glare from the element.

Model	Product type	Compatible light models
MDF-DQ108	Square oblique light diffusion plate	MDQL-CR(CG,CB,CW) for 108, 4 pieces/set
MDF-DR10	Diffusion plate for direct-ring lights	MDRL-CR (CG,CB,CW) for 10
MDF-DR16	Diffusion plate for direct-ring lights	MDRL-CR (CG,CB,CW) for 16
MDF-DR28	Diffusion plate for direct-ring lights	MDRL-CR (CG,CB,CW) for 28
MDF-DR31	Diffusion plate for direct-ring lights	MDRL-CR (CG,CB,CW) for 31
MDF-DR50	Diffusion plate for direct-ring lights	MDRL-CR (CG,CB,CW) for 50
MDF-DR56	Diffusion plate for direct-ring lights	MDRL-CR (CG,CB,CW) for 56
MDF-LR25	Diffusion plate for low-angle ring lights	MLRL-CR (CG,CB,CW) for 25
MDF-LR48	Diffusion plate for low-angle ring lights	MLRL-CR (CG,CB,CW) for 48
MDF-LR68	Diffusion plate for low-angle ring lights	MLRL-CR (CG,CB,CW) for 68
MDF-LR100	Diffusion plate for low-angle ring lights	MLRL-CR (CG,CB,CW) for 100
MDF-BR5015	Diffusion plate for bar lights	MBRL-CR (CG,CB,CW) for 5015
MDF-BR7530	Diffusion plate for bar lights	MBRL-CR (CG,CB,CW) for 7530
MDF-BR13015	Diffusion plate for bar lights	MBRL-CR (CG,CB,CW) for 13015

An asterisk (\*) in "compatible light models" refers to any LED color (R,G,B or W) of the light.

Polarizing plate:MPL Series

The MPL series polarizing plates are attached to LEDs in order to reduce unwanted glare and reflection during image processing.

Model	Product type	Compatible light models
MPL-DQ108	Square oblique light polarizing plate	MDQL-CR(CG,CB,CW) for 108, 4 pieces/set
MPL-SC56	Simulated coaxial light polarizing plate	MSCL-CR (CG,CB,CW) for 56
MPL-SC74	Simulated coaxial light polarizing plate	MSCL-CR (CG,CB,CW) for 74
MPL-SC105	Simulated coaxial light polarizing plate	MSCL-CR (CG,CB,CW) for 105
MPL-DR10-B	Polarizing plate for direct-ring lights	MDRL-CR (CG,CB,CW) for 10
MPL-DR16-B	Polarizing plate for direct-ring lights	MDRL-CR (CG,CB,CW) for 16
MPL-DR28-B	Polarizing plate for direct-ring lights	MDRL-CR (CG,CB,CW) for 28
MPL-DR31-B	Polarizing plate for direct-ring lights	MDRL-CR (CG,CB,CW) for 31
MPL-DR50-B	Polarizing plate for direct-ring lights	MDRL-CR (CG,CB,CW) for 50
MPL-DR56-B	Polarizing plate for direct-ring lights	MDRL-CR (CG,CB,CW) for 56
MPL-BR5015-B	Polarizing plate for bar lights	MBRL-CR (CG,CB,CW) for 5015
MPL-BR7530-B	Polarizing plate for bar lights	MBRL-CR (CG,CB,CW) for 7530
MPL-BR13015-B	Polarizing plate for bar lights	MBRL-CR (CG,CB,CW) for 13015

An asterisk (\*) in "compatible light models" refers to any LED color (R,G,B or W) of the light.

Adapter : MAD Series

The MAD series is essential when a diffusion or polarizing plate is attached to a ring light.

Model	Product type	Compatible light models
MAD-DR10	Plate attachment adapter for direct-ring lights	MDRL-CR (CG,CB,CW) for 10
MAD-DR16	Plate attachment adapter for direct-ring lights	MDRL-CR (CG,CB,CW) for 16
MAD-DR28	Plate attachment adapter for direct-ring lights	MDRL-CR (CG,CB,CW) for 28
MAD-DR31	Plate attachment adapter for direct-ring lights	MDRL-CR (CG,CB,CW) for 31
MAD-DR50	Plate attachment adapter for direct-ring lights	MDRL-CR (CG,CB,CW) for 50
MAD-DR56	Plate attachment adapter for direct-ring lights	MDRL-CR (CG,CB,CW) for 56

An asterisk (\*) in "compatible light models" refers to any LED color (R,G,B or W) of the light.

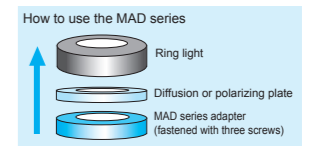

Light control film : MLM Series

The MLM series are resin films that transform diffused light into near-parallel light. Attached to a simulated coaxial light, it makes the light distribution pattern smoother.

Model	Product type	Compatible light models
MLM-SC56	Light control film for simulated coaxial lights	MSCL-CR (CG,CB,CW) for 56
MLM-SC74	Light control film for simulated coaxial lights	MSCL-CR (CG,CB,CW) for 74
MLM-SC105	Light control film for simulated coaxial lights	MSCL-CR (CG,CB,CW) for 105

An asterisk (\*) in "compatible light models" refers to any LED color (R,G,B or W) of the light.

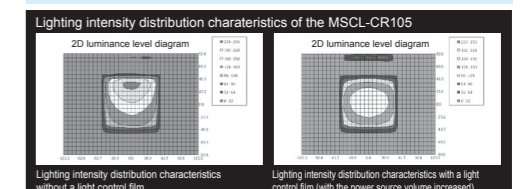
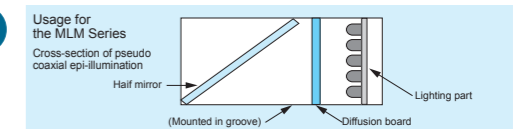

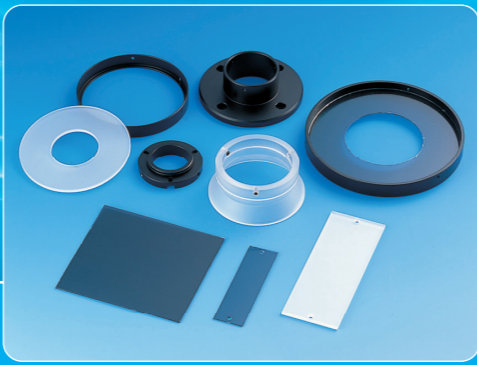

## Options for bridging lights with lenses

The following optional adapters are designed to be used with Moritex's lenses.

### Simulated Coaxial Light/CCTV Lens Adapter: MLA-SC Series

The MLA-SC Series enables small simulated coaxial lights to be mounted at the end of CCTV lenses.

Model	Product type	Compatible light models
MLA-SCBS	Mount base for simulated coaxial lights	MSCL-C*24/39/56
MLA-SCM255	Base/lens adapter for simulated coaxial lights	M25.5P0.5 lens
MLA-SCM270	Base/lens adapter for simulated coaxial lights	M27P0.5 lens
MLA-SCM305	Base/lens adapter for simulated coaxial lights	M30.5P0.5 lens

An asterisk (\*) in "compatible light models" refers to any LED color (R,G,B or W) of the light.  
\*Do not apply any unnecessary load to the lens.

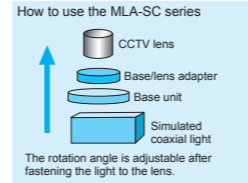

### MML/CCTV Lens Adapter

The adapter can be easily used in combination with Moritex's lenses.

Model	Product type	Compatible light models
MLA-DR1616	Lens attachment adapter	MDRL-C*16 and R-16 mm lenses
MLA-DR3125	Lens attachment adapter	MDRL-C*31 and R-25 mm lenses
MLA-DR3130	Lens attachment adapter	MDRL-C*31 and R-30 mm lenses
MLA-DR31M255	Lens attachment adapter	MDRL-C*31 and M25.5P0.5 lenses
MLA-DR31M270	Lens attachment adapter	MDRL-C*31 and M27P0.5 lenses
MLA-DR31M305	Lens attachment adapter	MDRL-C*31 and M30.5P0.5 lenses

An asterisk (\*) in "compatible light models" refers to any LED color (R,G,B or W) of the light.

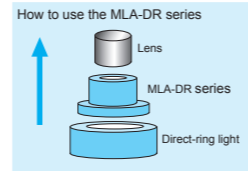

### Sharp-cut Filter R64 Series

These Filters can be attached to the end of a CCTV lens to prevent light interference when using red light.

Model	Product type	Size
ML-R64-25	Sharp-cut filter for mounting to end of lens	M25.5 P0.5 lens
ML-R64-27	Sharp-cut filter for mounting to end of lens	M27 P0.5 lens
ML-R64-30	Sharp-cut filter for mounting to end of lens	M30.5 P0.5 lens

## Cables

Model	Cable Diagram	Product type	Applications	Length
M-RCB401L	A	4-pin type extension cable	•For all lights (except the MCEP series)	1m
M-RCB402L	A	4-pin type extension cable		2m
M-RCB403L	A	4-pin type extension cable		3m
M-RCB301L	B	3-pin type extension cable	•For the MCEP series	1m
M-RCB302L	B	3-pin type extension cable		2m
M-RCB303L	B	3-pin type extension cable		3m
M-XS402C	C	Pin type extension cable	•For the MSPP series	2m
M-XS405C	C	Pin type extension cable		5m
M-XS410C	C	Pin type extension cable		10m
M-RCB301XS	D	Pin type MSPP-MLEP-A070 conversion cable	•For the MSPP series and MLEP-A070	1m
M-RCB001L	E	2-pin type extension cable	•For power sources for built-in fans	1m
M-RCB002L	E	2-pin type extension cable		2m
M-RCB003L	E	2-pin type extension cable		3m
MC-EXC-02	—	Cable for DSUB15 pin external control	—	2m
MC-EXC-07	—	Cable for DSUB15 pin external control	—	—
MRC-601L	F	6-pin round connector extension cable	•For the strobe controller 3Z4S-LT MLEK-C080E1LS (Camera connection)	1m

### Cable Diagrams

